

User manual  
**Temperature Calibrator**  
JOFRA ITC-155/320/650 A



# User manual

## Temperature Calibrator

### JOFRA ITC-155/320/650 A

© Copyright 2005 AMETEK DENMARK A/S (123311-UK)





FIG. 1

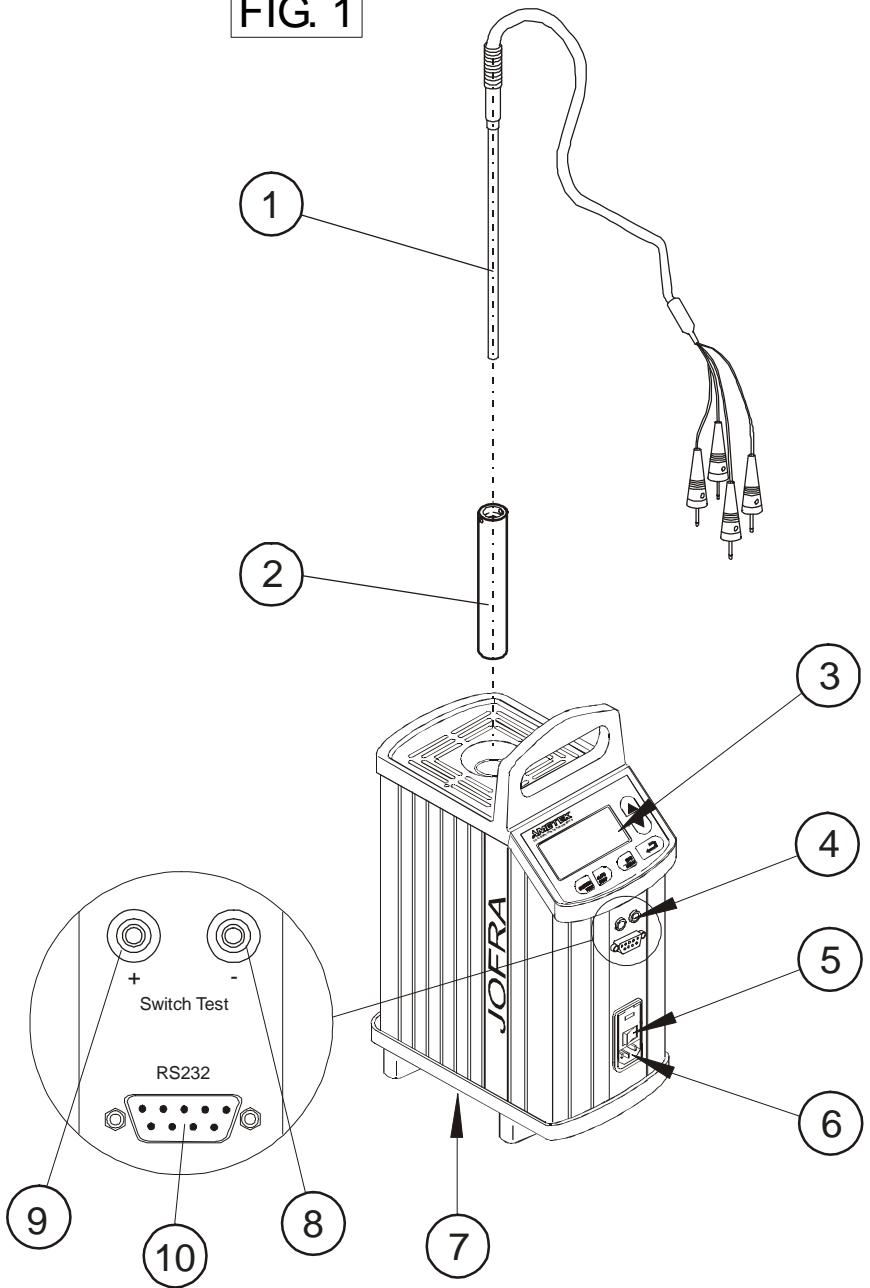

FIG. 2

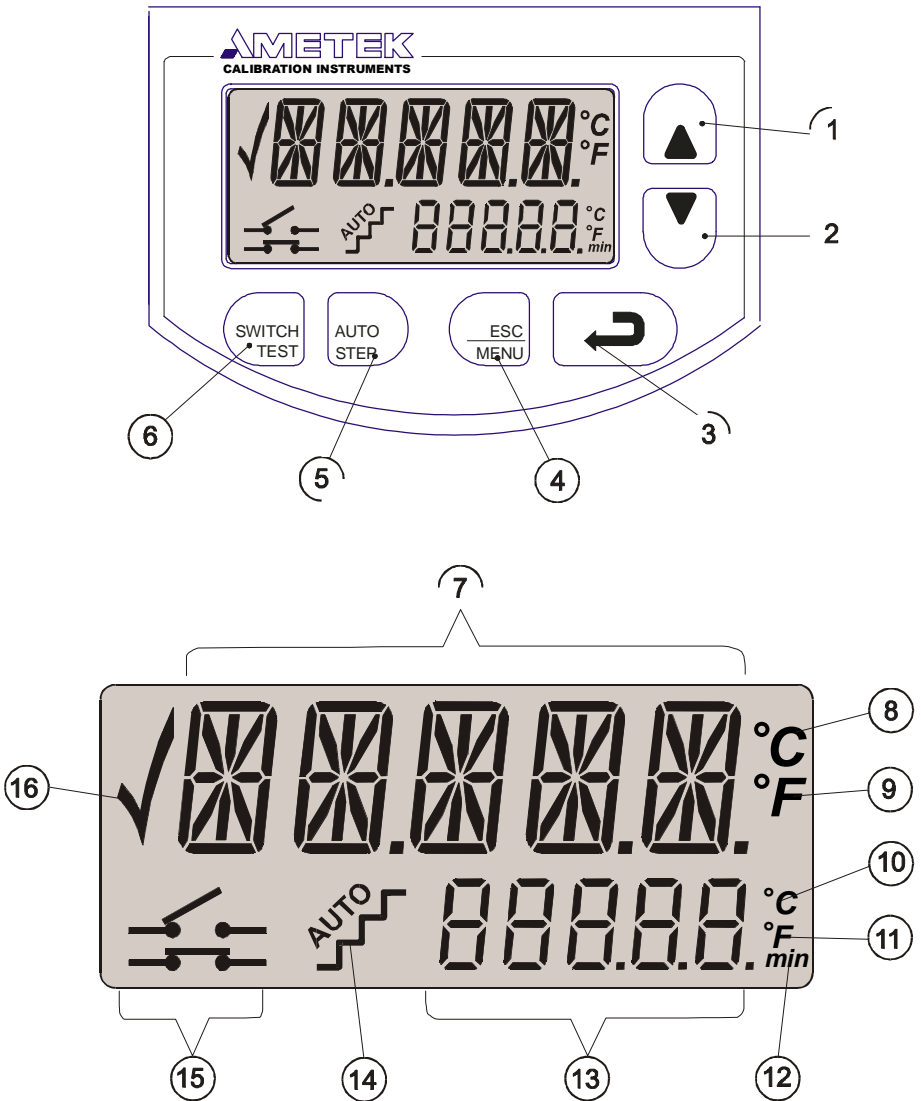

FIG. 3

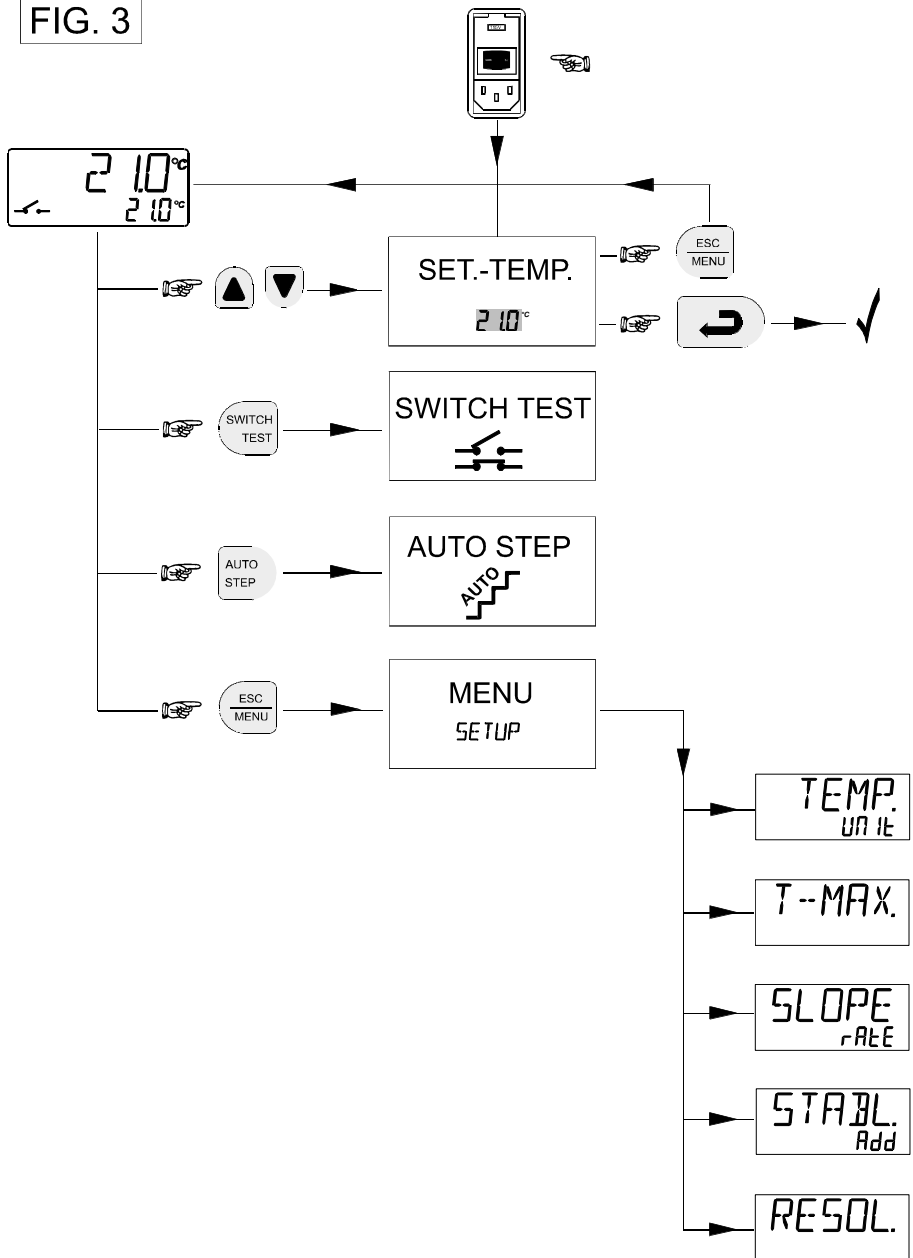

FIG. 4

SWITCH  
TEST

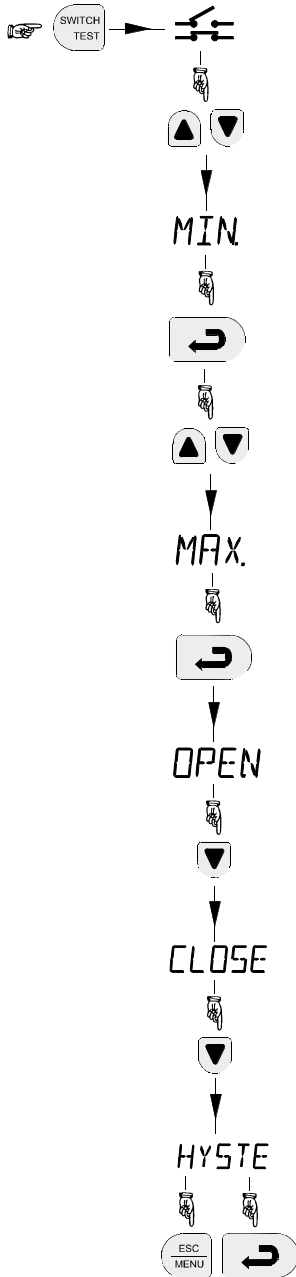

FIG. 5

AUTO  
STEP

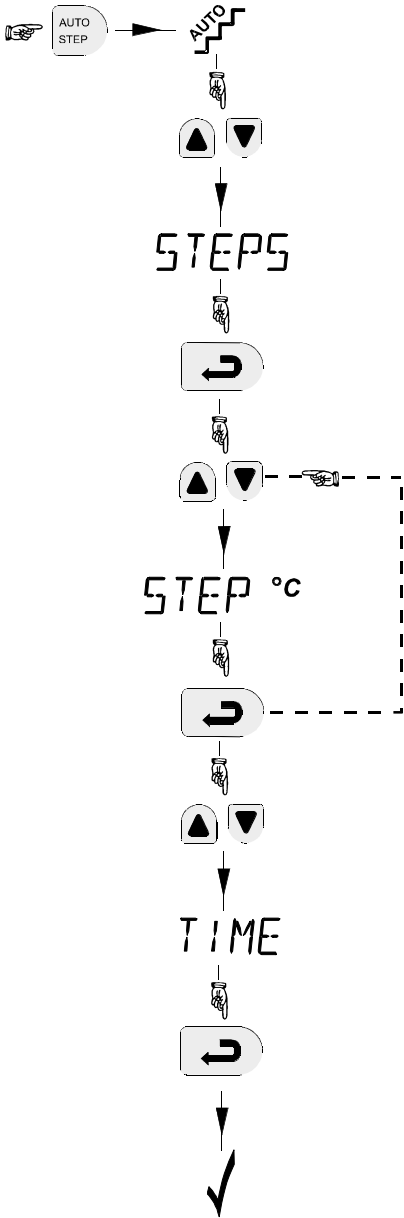
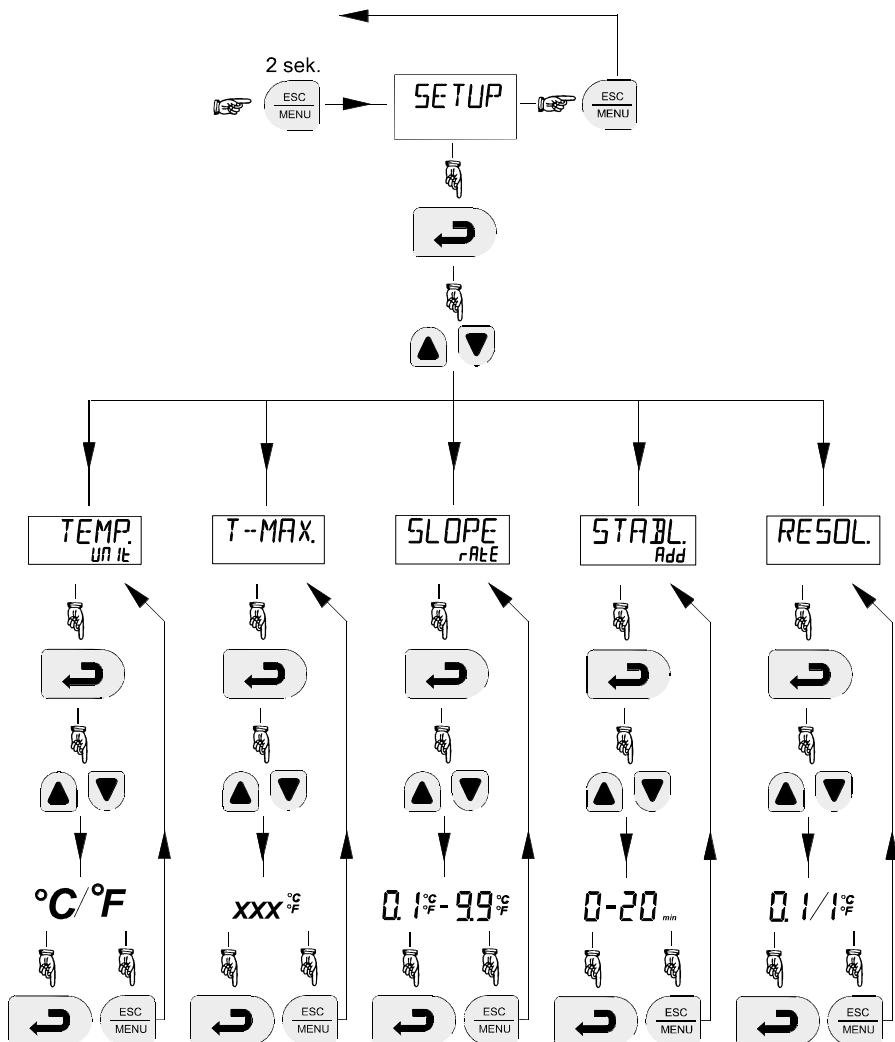



FIG. 6

ESC  
MENU



# List of contents

---

<b>1.0</b>	<b>Introduction.....</b>	<b>2</b>
1.1	List of equipment received.....	2
<b>2.0</b>	<b>Safety instructions .....</b>	<b>3</b>
<b>3.0</b>	<b>Operating the calibrator .....</b>	<b>8</b>
3.1	Before use.....	8
3.2	Keyboard.....	11
3.3	Display .....	11
3.4	Connections .....	12
3.5	Calibrator functions - overview.....	12
3.6	Selecting the set-temperature.....	12
3.7	SWITCH TEST .....	13
3.8	AUTO STEP .....	14
3.9	MENU.....	15
<b>4.0</b>	<b>Setting the main voltage and replacing the fuses ....</b>	<b>16</b>
<b>5.0</b>	<b>After use .....</b>	<b>18</b>
5.1	Switching off the calibrator.....	19

# 1.0 Introduction

---

ITC-calibrators are temperature calibrators designed to calibrate temperature sensors and temperature switches.

Read this manual carefully before using the instrument and make sure that all safety instructions and warnings are observed.

## 1.1 List of equipment received

When you receive the instrument, the following should be enclosed:

- 1 calibrator
- 1 mains cable
- 1 set of test cables (1 black, 1 red)
- 1 insertion tube
- 1 tool for insertion tube
- 1 traceable certificate
- 1 reference manual
- 1 user manual
- RS232 serial cable
- 1 CD-ROM containing software package “JOFRACAL” (The adjustment software “AmeTrim” is **not** applicable to the ITC-calibrators)

## 2.0 Safety instructions

---



### Read this manual carefully before using the instrument!

In order to avoid any personal injuries and/or damage to the instrument all safety instructions and warnings must be observed.



### Disposal – WEEE Directive

These calibrators contain Electrical and Electronic circuits and must be recycled or disposed of properly (in accordance with the WEEE Directive 2002/96/EC).



### Warning

#### About the use:

- The calibrator **must not** be used for any purposes other than those described in this manual, as it might cause a hazard.
- The calibrator has been designed for **indoor use only** and is not to be used in wet locations.
- The calibrator is **not to be used in hazardous areas**, where vapour or gas leaks, etc. may constitute a danger of explosion.
- The calibrator is **not** designed for operation in altitudes above 2000 meters.
- The calibrator is a CLASS I product and must be connected to a mains outlet with a protective earth connection. Ensure the ground connection of the calibrator is properly connected to the protective earth before switching on the calibrator. Always use a mains power cable with a mains plug that connects to the protective earth.

- To ensure the connection to protective earth any extension cord used **must** also have a protective earth conductor.
- Only use a mains power cord with a current rating as specified by the calibrator and which is approved for the voltage and plug configuration in your area.
- Before switching on the calibrator make sure that it is set to the voltage of the mains electricity supply.
- **Always** position the calibrator to enable easy and quick disconnection of the power source (mains inlet socket).
- The calibrator **must** be kept clear within an area of 20 cm on all sides and 1 metre above the calibrator due to fire hazard.
- **Never** use heat transfer fluids such as silicone, oil, paste, etc. in the dry-block calibrators. These fluids may penetrate the calibrator and cause electrical hazard, damage or create poisonous fumes.
- The calibrator **must** be switched off before any attempt to service the instrument is made. There are no user serviceable parts inside the calibrator.
- When cleaning the well or insertion tube, **REMEMBER** to wear goggles when using compressed air!

### **About the front panel:**

- The connections used to test thermostats must **NEVER** be connected to a voltage source.
- Thermostats must **not** be connected to any other voltage source during a test.

### **About the insertion tubes, insulation plug, well and sensor:**

- **Never** leave hot insertion tubes which have been removed from the calibrator unsupervised – they may constitute a fire hazard or personal injury.

If you intend to store the calibrator in the optional carrying case after use, you **must** ensure that the instrument has cooled down to a temperature **below 100°C/212°F** before placing it in the carrying case.

- **Never** place a hot insertion tube in the optional carrying case.
- Use only insulation plugs supplied by AMETEK Denmark A/S.

### About the fuses:

- The fuse box must not be removed from the power control switch until the mains cable has been disconnected.
- The two main fuses must have the specified current and voltage rating and be of the specified type. The use of makeshift fuses and the short-circuiting of fuse holders are prohibited and may cause a hazard.



### Caution – Hot surface



This symbol is engraved in the grid plate.

- **Do not touch** the grid plate, the well or the insertion tube when the calibrator is heating up – they may be very hot and cause burns.
- **Do not touch** the tip of the sensor when it is removed from the insertion tube/well – it may be very hot and cause burns.
- **Do not touch** the handle of the calibrator during use – it may be very hot and cause burns.
- **Over 50°C/122°F**  
If the calibrator has been heated up to temperatures above 50°C/122°F, you must wait until the instrument reaches a temperature **below 50°C/122°F** before you switch it off.
- **Do not** remove the insert from the calibrator before the insert has cooled down to less than 50°C/122°F.



## Caution – Cold surface

Below 0°C/32°F (applies only to the ITC-155 A models)

- **Do not** touch the well or insertion tube when these are below 0°C/32°F - they might create frostbite.
- If the calibrator has reached a temperature below 0°C/32°F, ice crystals may form on the insertion tube and the well. This, in turn, may cause the material surfaces to oxidize

To prevent this from happening, simply heat up the calibrator to 100°C/212°F until all water left has evaporated.

Remove the insulation plug while heating up.

It is very important that humidity in the well and insertion tube is removed to prevent corrosion and frost expansion damages.



## Caution...

### About the use:

- **Do not** use the instrument if the fan is out of order.
- Before cleaning the calibrator, you **must** switch it off, allow it to cool down and remove all cables.

### About the well, insertion tube and grid plate:

- The well and the insertion tube **must** be clean before use.
- **Do not** pour any form of liquids into the well. It might damage the well or cause a hazard.
- Scratches and other damage to the insertion tubes should be avoided by storing the insertion tubes carefully when not in use.
- The insertion tube must **never** be forced into the well. The well could be damaged as a result, and the insertion tube may get stuck.
- The insertion tube must **always** be removed from the

calibrator after use.

The humidity in the air may cause corrosion oxidation on the insertion tube inside the instrument. There is a risk that the insertion tube may be stuck if this is allowed to happen.

- If the calibrator is to be transported, the insertion tube **must** be removed from the well to avoid damage to the instrument.



### **Note...**

The product liability **only** applies if the instrument is subject to a manufacturing defect. This liability becomes void if the user fails to follow the instructions set out in this manual or uses unauthorised spare parts.



## 3.0 Operating the calibrator

---

### 3.1 Before use



#### Warning

- The calibrator **must not** be used for any purposes other than those described in this manual, as it might cause a hazard.
- The calibrator has been designed for **indoor use only** and is not to be used in wet locations.
- The calibrator is **not to be used in hazardous areas**, where vapour or gas leaks, etc. may constitute a danger of explosion.
- The calibrator is **not** designed for operation in altitudes above 2000 meters.
- The calibrator is a CLASS I product and must be connected to a mains outlet with a protective earth connection. Ensure the ground connection of the calibrator is properly connected to the protective earth before switching on the calibrator. Always use a mains power cable with a mains plug that connects to the protective earth.
- To ensure the connection to protective earth any extension cord used **must** also have a protective earth conductor.
- Only use a mains power cord with a current rating as specified by the calibrator and which is approved for the voltage and plug configuration in your area.
- Before switching on the calibrator make sure that it is set to the voltage of the mains electricity supply.
- **Always** position the calibrator to enable easy and quick disconnection of the power source (mains inlet socket).
- The connections used to test thermostats (fig. 1 pos. 8 and 9) must **NEVER** be connected to a voltage source.
- Thermostats must **not** be connected to any other voltage source during a test.

- **Never** use heat transfer fluids such as silicone, oil, paste, etc. in the dry-block calibrators. These fluids may penetrate the calibrator and cause electrical hazard, damage or create poisonous fumes.
- The calibrator **must** be kept clear within an area of 20 cm on all sides and 1 metre above the calibrator due to fire hazard.
- Use only insulation plugs supplied by AMETEK Denmark A/S.



### Caution – Hot surface



This symbol is engraved in the grid plate.

- **Do not touch** the grid plate, the well or the insertion tube when the calibrator is heating up – they may be very hot and cause burns.
- **Do not touch** the handle of the calibrator during use – it may be very hot and cause burns.

Follow the instructions below before using the calibrator (cf. Fig. 1):

1. Place the calibrator on an even horizontal surface away from all draughts.



### Caution...

**Do not** use the instrument if the fan is out of order. Ensure a free supply of air to the fan located at the bottom of the instrument (pos. 7).

2. Check that the voltage shown on the power control switch (pos. 5) is identical to the mains voltage.
3. Plug in the cable below the power control switch (pos. 6) and check that the earth connection is present.
4. Select an insertion tube (pos. 2) with a well diameter that matches the sensor (pos. 1) to be calibrated. Insert the insertion tube in the well of the calibrator



### Caution...

- The well and the insertion tube **must** be clean before use.
- The insertion tube must **never** be forced into the well. The well could be damaged as a result, and the insertion tube may get stuck.
- **Do not** pour any form of liquids into the well. It might damage the well or cause a hazard.

5. Place the sensor (pos. 1) in the insertion tube (pos. 2) as shown in Fig. 1.
6. In order to spare the sensor and its connections it is recommended to use a heat protection shield (104216) at high temperatures.

## 3.2 Keyboard

The keys on the keyboard activate the following functions (cf. Fig. 2):

POS	Description
-----	-------------

- |   |   |
|---|---|
| ① | <b>UP ARROW</b> button used to adjust temperature values (value increases) and to select menu options.  |
| ② | <b>DOWN ARROW</b> button used to adjust temperature values (value decreases) and to select menu options.  |
| ③ | <b>ENTER</b> button used to accept chosen options.  |
| ④ | <b>ESC/MENU</b> button used to escape or to activate the menu system (hold button down for min. 2 seconds).                                     |
| ⑤ | <b>AUTO STEP</b> button used to activate AUTO STEP.<br>The function is used to switch between a series of set-temperatures automatically.       |
| ⑥ | <b>SWITCH TEST</b> button used to activate SWITCH TEST.<br>The function automatically detects the opening/closing temperatures for thermostats. |

## 3.3 Display

The various segments of the display are used to indicate the following (cf. Fig. 2):

POS	Description
-----	-------------

- |                 |   |
|-----------------|---|
| ⑦               | Used to display Read-temperature and parameters in the menu system. |
| ⑧               | Celsius temperature unit for top display.                           |
| ⑨               | Fahrenheit temperature unit for top display.                        |
| ⑩               | Celsius temperature unit for bottom display.                        |
| 11 <sup>↑</sup> | Fahrenheit temperature unit for bottom display.                     |
| 12 <sup>↓</sup> | Minute time unit for bottom display.                                |

- 13 Used to display set-temperature, time-until-stable and parameter values in the menu system.
- 14 AUTO STEP symbol used to indicate that the function is active (symbol flashes repeatedly).
- 15 SWITCH TEST input closed.  
SWITCH TEST input open.
- 16 Check mark displayed when the calibrator is stable.

### 3.4 Connections

The instrument is designed for the following connections (cf. Fig. 1):

POS	Description
-----	-------------



- |   |                                  |
|---|----------------------------------|
| ⑧ | Connection of black test cable - |
| ⑨ | Connection of red test cable +   |
| ⑩ | Connection of RS232 cable        |



**Note** that all PC-equipment, which are connected to the calibrator must observe the directive IEC950.



### 3.5 Calibrator functions - overview

The instrument's functions are divided into hierarchical groups. See the key diagram in Fig. 3.

### 3.6 Selecting the set-temperature

 Press  or . The current set-temperature flashes (the starting point is the last chosen set-temperature even if the instrument has been switched off).



 Press  or  to select the required temperature.



 Press  to accept the change or  to cancel and return to the previous value.

The calibrator will now work towards the new set-temperature.



### 3.7 SWITCH TEST



The SWITCH TEST function (cf. Fig. 4) automatically locates the opening/closing temperatures of a thermostat. You must enter a  $T_{\min}$  - and a  $T_{\max}$  -temperature which define the range within which the opening/closing temperatures are expected to be found.

 Press . The last chosen  $T_{\min}$  -temperature value will flash.

 Press  or  to set the required  $T_{\min}$  -temperature.



 Press  to accept your selection.

 Press  or  to set the required  $T_{\max}$  -temperature.

 Press  to accept your selection. The function is activated.





















Once the opening/closing temperatures have been located, the instrument will display the values as *CLOSE* (the closing temperature), *OPEN* (the opening temperature) and *HYSTE*. (the difference between the opening/closing temperatures) respectively. If a temperature has not been found, the instrument will display *Error*.

 To display the three temperatures, press  or .

 Press  to end the test or  to leave the function at any time.







### 3.8 AUTO STEP

The AUTO STEP function (cf. Fig. 5) is used to step automatically between a range of different set-temperatures.











-  Press . The instrument displays the number of set-temperature **STEPS**.
-  Press  or  to select the required number of steps.
-  Press  to accept your selection. The first set-temperature will flash.
-  Press  or  to select the required temperature.
-  Press  to accept your selection. The next set-temperature will flash. This process will be repeated until the last value has been accepted. The extra **TIME** for which you wish the calibrator to remain at every step will flash.
-  Press  or  to set the required number of minutes.
-  Press  to accept your selection. The function will be activated.
-  Press  after the last set-temperature to end the function or  to leave the function at any time.

## 3.9 MENU

The MENU function (cf. Fig. 6) is used to modify the SETUP parameters.

-  Hold down  for approx. 2 seconds. The word *SETUP* will appear on the display.
-  Press . The first SETUP parameter will be displayed.
-  Press  or  to toggle between the SETUP parameters:

*TEMP. unit:* Temperature unit °C or °F.  
*T--MAX.:* The highest permissible temperature for the calibrator.  
*SLOPE RATE:* Temperature change per minute used in connection with SWITCH TEST.  
*STABL. Add:* Extra time which must elapse once the well is stable before the check mark symbol is displayed.  
*RESOL.:* Temperature resolution of 0 or 1 decimal.

-  Press  to select the SETUP parameter you wish to change. The current value will flash.
-  Press  or  to select the required value.
-  Press  to accept your selection or  to cancel and return to the previous value.
-  Once you have changed all SETUP parameters as required, cancel the function by pressing  twice.



## 4.0 Setting the main voltage and replacing the fuses



### Warning

- The fuse box must not be removed from the power control switch until the mains cable has been disconnected.
- The two main fuses must have the specified current and voltage rating and be of the specified type. The use of makeshift fuses and the short-circuiting of fuse holders are prohibited and may cause a hazard.

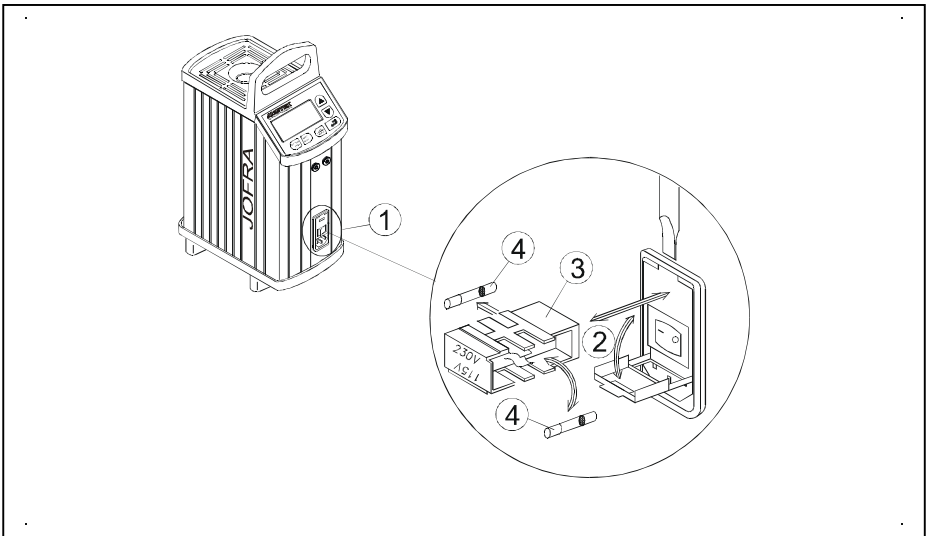

- ① Locate the main fuses in the fuse box in the power control switch and check the voltage of the power control switch (on/off switch (230V/115V)). If the voltage of the power control switch differs from the line voltage, you must adjust the voltage of the power control switch.
- ② Open the lid of the fuse box using a screwdriver.
- ③ Remove the fuse box.
- ④ Remove both fuses and insert two new fuses. These must be identical and should correspond to the line voltage.

- **ITC-155:** 115V, 2AT = 105014 / 230V, 1AT = 105007
- **ITC-320/650:** 115V, 10AF = 60B302 / 230V, 5AF = 60B301

If the fuses blow immediately after you have replaced them, the calibrator should be returned to the manufacturer for service.

Slide the fuse box into place with the correct voltage turning upwards.

## 5.0 After use

---



### Warning

**Never** leave hot insertion tubes which have been removed from the calibrator unsupervised – they may constitute a fire hazard or personal injury.

If you intend to store the calibrator in the optional carrying case after use, you **must** ensure that the instrument has cooled to a temperature **below 100°C/212°F** before placing it in the carrying case.



### Caution...

- The insertion tube must **always** be removed from the calibrator after use.

The humidity in the air may cause corrosion oxidation on the insertion tube inside the instrument. There is a risk that the insertion tube may get stuck if this is allowed to happen.

- If the calibrator is to be transported, the insertion tube **must** be removed from the well to avoid damage to the instrument.
- Scratches and other damage to the insertion tubes should be avoided by storing the insertion tubes carefully when not in use.



### Caution – Hot surface

- **Do not touch** the grid plate, the well or the insertion tube - they may be very hot and cause burns.
- **Do not touch** the tip of the sensor when it is removed from the insertion tube/well – it may be very hot and cause burns.
- **Do not** remove the insert from the calibrator before the insert has cooled down to less than 50°C/122°F.

## 5.1 Switching off the calibrator

The following routine must be observed before the insertion tube is removed and the instrument switched off (cf. Fig. 1):

1. If the calibrator has been heated up to temperatures above 50°C/122°F, you must wait until the instrument reaches a temperature **below 50°C/122°F** before you switch it off.
2. If the calibrator has reached a temperature below 0°C/32°F, it should be heated momentarily to a temperature of 100°C/212°F.
3. Switch off the calibrator using the power control switch (pos. 5).
4. Remove the insertion tube from the calibrator using the tool supplied with the instrument.
5. **Optional:** Store the calibrator in the carrying case.

#### **AMETEK Test & Calibration Instruments**

A business unit of AMETEK Measurement & Calibration Technologies Division offering the following industry leading brands for test and calibration instrumentation.

#### **JOFRA Calibration Instruments**

##### *Temperature Calibrators*

Portable dry-block calibrators, precision thermometers and liquid baths. Temperature sensors for industrial and marine use.

##### *Pressure Calibrators*

Convenient electronic systems ranging from -25 mbar to 1000 bar - fully temperature-compensated for problem-free and accurate field use.

##### *Signal Instruments*

Process signal measurement and simulation for easy control loop calibration and measurement tasks.

#### **M&G Dead Weight Testers & Pumps**

Pneumatic floating-ball or hydraulic piston dead weight testers with accuracies to 0.015% of reading. Pressure generators delivering up to 1,000 bar.

#### **Crystal Pressure**

Digital pressure gauges and calibrators that are accurate, easy-to-use and reliable. Designed for use in the harshest environments; most products carry an IS, IP67 and DNV rating.

#### **Lloyd Materials Testing**

Materials testing machines and software that guarantees expert materials testing solutions. Also covering Texture Analysers to perform rapid, general food testing and detailed texture analysis on a diverse range of foods and cosmetics.

#### **Davenport Polymer Test Equipment**

Allows measurement and characterization of moisture-sensitive PET polymers and polymer density.

#### **Chatillon Force Measurement**

The hand held force gauges and motorized testers have earned their reputation for quality, reliability and accuracy and they represent the de facto standard for force measurement.

#### **Newage Hardness Testing**

Hardness testers, durometers, optical systems and software for data acquisition and analysis.



**TEST & CALIBRATION INSTRUMENTS**

#### **United Kingdom**

Tel +44 (0)1243 833 302  
jofra@ametek.co.uk

#### **France**

Tel +33 (0)1 30 68 89 40  
general.lloyd-instruments@ametek.fr

#### **Germany**

Tel +49 (0)2159 9136 510  
info.mct-de@ametek.de

#### **Denmark**

Tel +45 4816 8000  
jofra@ametek.com

#### **USA**

*Florida*  
Tel +1 (800) 527 9999  
cal.info@ametek.com

#### *California*

Tel +1 (800) 444 1850  
sales@crystalengineering.net

#### **India**

Tel +91 22 2836 4750  
jofra@ametek.com

#### **Singapore**

Tel +65 6484 2388  
jofra@ametek.com

#### **China**

*Shanghai*  
Tel +86 21 5868 5111

#### *Beijing*

Tel +86 10 8526 2111

#### *Guangzhou*

Tel +86 20 8363 4768  
jofra.sales@ametek.com.cn

[www.ametekcalibration.com](http://www.ametekcalibration.com)